

Fail-Safe-Function with Positioner NR-C1

Fail-Safe-Function via Capacitor:

The Fail-Safe-Function with Positioner NR-C1 is used to drive a DC-Actuator in case of missing power supply into a choosable final position.

If the 24VDC-power supply gets lost at terminals 7 and 8, the actuator drives into the via jumper „Err.-Drive“ set end position. At the same time, the relay „Power-Fail“ picks up and the LED (Power-Fail) flashes. On return of the 24VDC-power supply, the system switches back to normal operation. The maintenance-free capacitor memory is loaded again within maximum 10 minutes.

In case of heaviness or blocking of the actuator, the control switches off the actuator over the increased current consumption. At the same time, the relay „Motor-Err“ picks up and the LED (Mot-Err) flashes. The drive is ready for use again by reversing or switching off the supply voltage for approx. 1s.

Caution! The emergency function is activated when the supply voltage is switched off. This can be prevented by setting the operating switch to “Manuell” or by disconnecting the plug from the capacitor memory.

Before commissioning of the actuator, the stabilized 24VDC-power supply should be connected to the terminals 7 and 8 when the operating switch is set to “Manuell” and the limit switches as well as any other positioning options are set. Meanwhile, the relay "Power Fail" is picked up and the LED (Con-Low) is lit.

After this, the fault-free function of the emergency capacitor memory should be checked in auto mode by switching off the supply voltage . The charging time of an empty capacitor is about 10 minutes. In case of sufficient capacitor memory voltage, the relay "Power Fail" drops off and the LED goes out (Con-Low).

In case of less capacitor memory voltage, the fail safe relay (Power-Fail) picks up and the LED flashes (Con-Low).

Reverse polarity or wrong connection may destroy the circuit.

Technical data:

Power supply: 24VDC, stabilized

Set values: 0/2-10V or 0/4-20mA

Actual values: 0/2-10V or 0/4-20mA

Capacitor memory capacities: 5,5F or 11F

Capacitor memory voltage: 24VDC

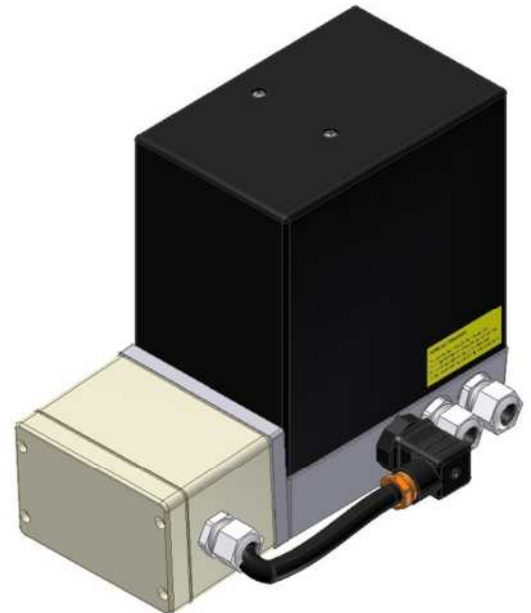

General

The Fail-Safe-Function with Positioner NR-C1 is used to control a electric actuator with a continuous current or voltage signal.

Caution! When handling the charged capacitor memory, the stored energy (max 24VDC) must be observed.

Hardware-Description

The AGS positioner NR-C1 control consists of an internal power generation, a micro-controller as a control computer, an analog front end for the recording of analogue setpoints and potentiometer values, a digital power unit for connecting the DC motor as well as buttons, switches and LEDs as operating and display elements.

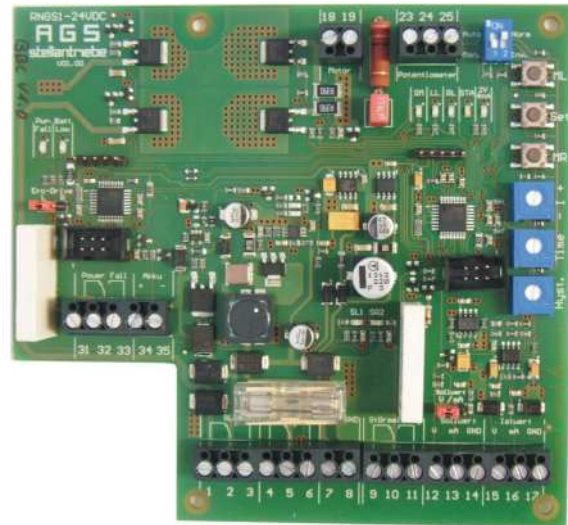

Control Computer

A microcontroller assesses the SET, MR and ML operating keys, the Man/Auto and Inv/Norm configuration switches, the active setting of the configuration potentiometer for current (=max. current limit) and time (= blocking threshold) and hysteresis (positioning accuracy) and the activation of the electro-mechanic limit-switches.

As a controlled variable, the microcontroller determines the absolute position of the drive and the externally introduced setpoint. An analogue actual value will be generated as power and voltage for the current drive position and provided on the terminals.

The control computer part comprises a blue status LED for the signalling of certain end position programming or operating conditions and a yellow LED that indicates the predefined setpoint / actual value range. The control computer is pre-programmed with the firmware over its 6 pole programming interface at the factory.

Power Part

The power part comprises the jumper switching stages for the motor, the respective LEDs as indicators for the active clockwise and counter-clockwise rotation and inputs with LED indicators for the detection of the motor discontinuation by the electro-mechanic end-switches of the drive.

Analogue Front-End

In the analogue circuit, the power or voltage setpoints fed externally into the terminals 12/13/14 will be converted into voltages that can be used by the control computer. However, a selection must be made via a jumper whether the voltage or power input terminal should be used.

The actual values of voltage and power will be generated from a PWM signal of the control computer and will be provided to the terminals 15/16/17.

A fault signal relay with indicator LED will be controlled directly by the control computer and provides a potential-free fault signal contact (1xUM) at terminals 9/10/11.

The setpoint input and the actual value output are galvanically connected and connected with the 24VDC supply voltage at the earth-side and/or with the minus-side!

Technical data:

Power supply:

24V Direct current, stabilized

Set value-In:

0/2 - 10V DC Ri = 10 kΩ

0/4 - 20mA Ri = 250 Ω

Actual value (active):

0/2-10V (Burden at least 5 kΩ)

0/4-20mA (Burden max. 500Ω)

Control accuracy:

ca. 1 - 6 % of the max. displacement depending on the regulating time, adjustable via Poti „Hyst%“

Capacitor memory capacities: 5,5F or 11F

Capacitor memory voltage: 24VDC

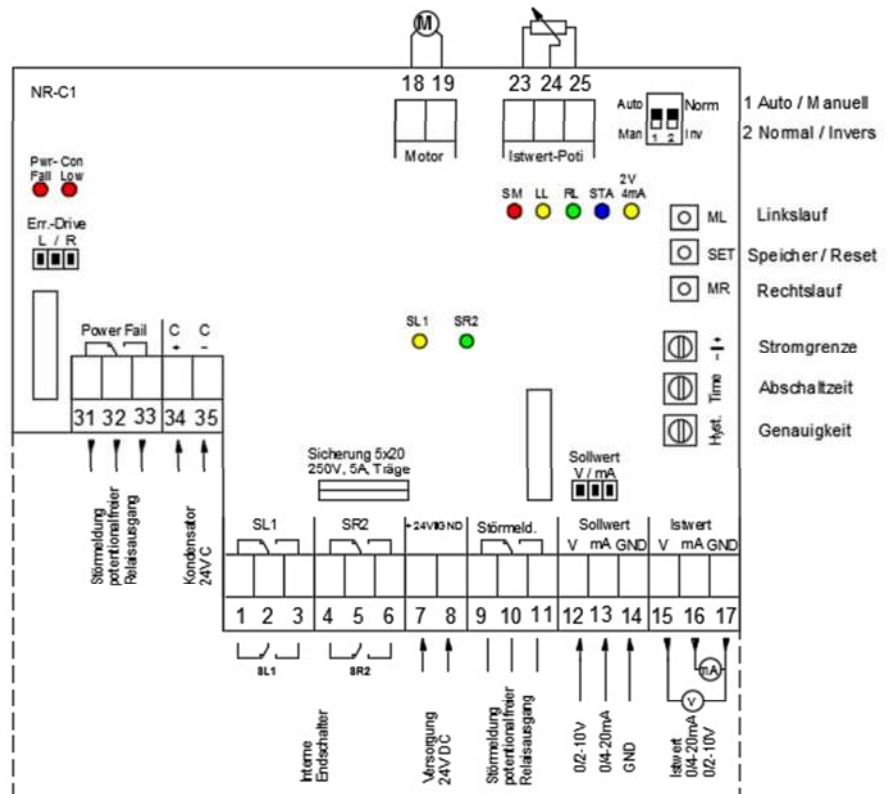

Overview of all LEDs

SM	Fault signal relay	RED during active fault message
LL	Motor in counter-clockwise rot.	YELLOW when motor is switched to counter-clockwise rotation
RL	Motor in clockwise rotation	GREEN when motor is switched to clockwise rotation
STA	Status	BLUE or BLUE FLASHING as status indication of the control computer
2V/4mA	Setpoint	YELLOW at 2V/4mA, OFF at 0V/0mA, flashing when below value 2V/4mA
SL1	End-switch, left	YELLOW when end-switch is activated with counter-clockwise rotation
SL1	End-switch, right	GREEN when end-switch is activated with clockwise rotation
PWR-Fail	Power supply	RED, when if missing power supply
Con Low	Capacitor	RED, when low or no capacitor memory

Übersicht Taster, Schalter, Steckbrücken und Sicherung

M/A	Manual/Automatic	Configuration slide switch for operational mode
Inv / Norm		Norm: 0/2-10V or 0/4-20mA, Invers: 10-0/2V or 20-0/4mA
ML	Manual counter-clockwise rotation	Key for counter-clockwise rotation or configuration
SET	Setting	Key for configuration or blocking reset
MR	Manual clockwise rotation	Key for clockwise rotation or configuration
Poti Speed		Setting of motor speed
Poti HYST		Setting hysteresis
Poti Power		Setting of power limit (switch-off moment of motor)
Fuse		Device fuse 5x20mm, 250V, 5A, time-lag in the fuse box
Set value		Jumper V/mA
Err.-Drive		Rotation direction, if missing power supply

Anschlussklemmen

- 01 End-switch SL1 (normally closed)
- 02 End-switch SL1 (Com)
- 03 End-switch SL1 (normally opened)
- 04 End-switch SR2 (normally closed)
- 05 End-switch SR2 (com)
- 06 End-switch SR2 (normally opened)
- 07 Mains 24V +
- 08 Mains 24V GND
- 09 Fault signal relay NC (if no(!) fault is present, the relay is closed)
- 10 Fault signal relay CO
- 11 Fault signal relay NO
- 12 Setpoint voltage input (0/4 ... 10V)
- 13 Setpoint power input (0/2 ... 20mA)
- 14 Setpoint reference potential mass (GND)
- 15 Actual value voltage output (0/4 ... 10V)
- 16 Actual value power output (0/2 ... 20mA)
- 17 Actual value reference potential mass (GND)

- 18 Motor
- 19 Motor

- 23 Position potentiometer reference potential mass (GND)
- 24 Position potentiometer pickoff, voltage between 0 ... 5V proportional to the angle
- 25 Position potentiometer 5V

- 31 Power Fail-Relay NC (in case of no failure relay is picked up, switches potential-free)
- 32 Power Fail-Relay CO
- 33 Power Fail-Relay NO

- 34 Capacitor 24V +
- 35 Capacitor 24V GND

Terminals 14, 17 and 23 (mass GND)

are electrically connected

Terminals 12-17 and 23-25 are electrically mounted to the low voltage potential of the controller electronics.

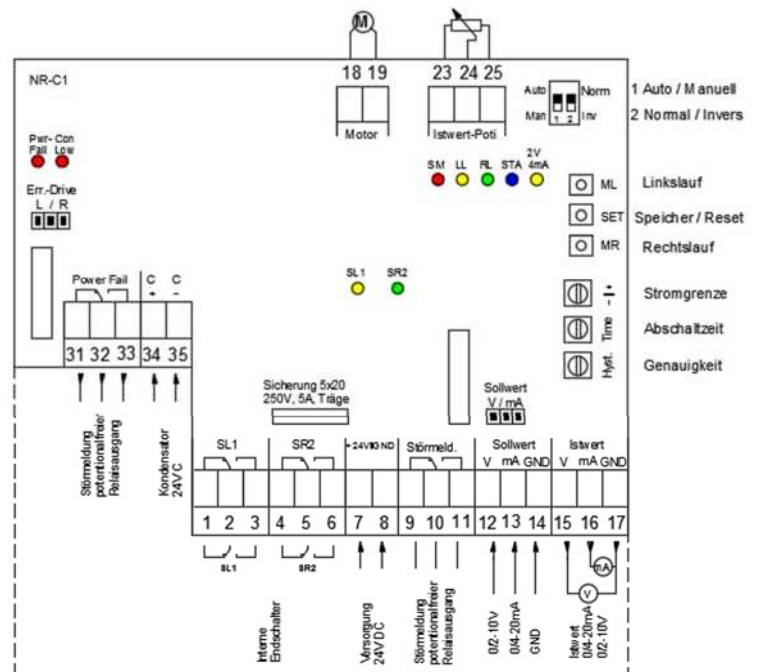

Basic setting before startup

Setting of the Manual mode

The position controller NR-C1 has to be set to manual mode before startup.
To do this, set the switch to "Man."

Caution! The Fail-Safe-Capacitor-Memory is disabled in manual mode.

Caution! The Fail-Safe capacitor memory should be connected with the actuator via the plug after having adjusted the positioner.

Manual-Mode (Man.)

The manual mode is used to program the final positions along with driving the any manual set of the drive left or right until you reach the electromechanical limit switch.

The fault relay is always activated in the manual mode, the display SM LED (red) lights up.

Following functions are available in the manual mode:

- manual driving to both directions
- programming of both final positions

Special functions for simultaneous switching on the operating voltage:

- Switching the analog setpoint / actual value range
- Inducing a rotation direction detection

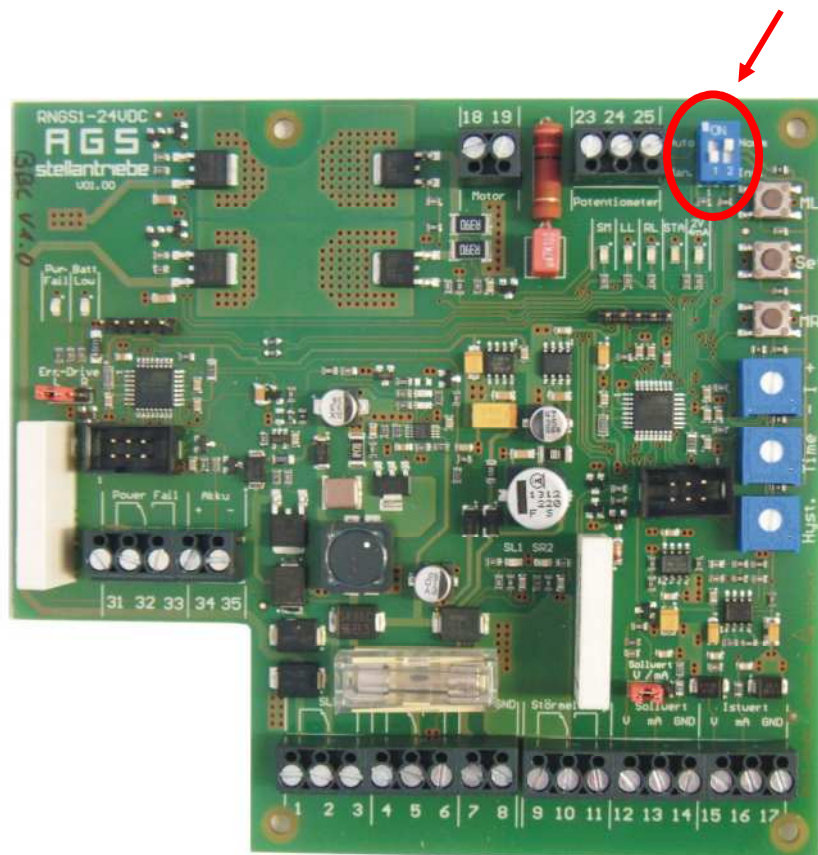

Selection Automatic / Manual-Mode via Switch Man./Auto

Selection of the set value

First, the "SW" jumper must be inserted on the desired selection (voltage or current). For the selection of the setpoint value, please now enter the supply voltage to terminals 7 and 8.

Switchover of the analogue Setpoint / Actual Value Ranges

In general, two value ranges can be selected for the valid setpoints and actual values:
 0 ... 10V and 0 ... 20mA or 2 ... 10V and 4 ... 20mA

For the selection of the setpoint as control voltage or control power, apart from the correct terminal selection, the "SW" jumper must be connected correctly.

The actual value at the respective terminals is always available both as voltage and as power.

In case of simultaneous pressing of the SET key and the ML key (for at least 1s) and connection of the operating voltage, the following setpoint / actual value range is selected:

2 ... 10V and 4 ... 20mA. LED "2V/4mA" flashes yellow.

In case of simultaneous pressing of the SET key and the MR key (for at least 1s) and connection of the operating voltage, the following setpoint / actual value range is selected:

0 ... 10V and 0 ... 20mA. LED "2/4mA" off.

Signalling of the Setpoint / Actual Value Range in the Manual and Automatic Mode

The state of the selected setpoint / actual value area is indicated by LED "2/4mA" (yellow).

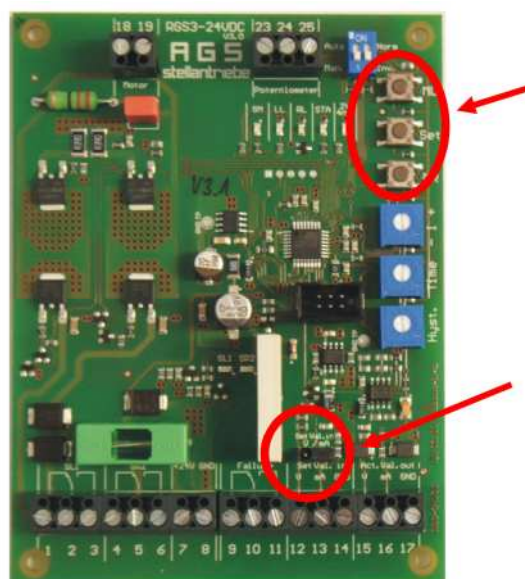

Rotation direction detection

The rotation direction detection is used to check the actuator and the function of the position determine poti. It is assumed that the connection of the motor is properly conducted and this direction of rotation right turns to the right.

The position controller NR-C1 has to be set to manual mode while programming the rotation direction. To do this, set the switch to "Man."

Caution! The Fail-Safe-Capacitor-Memory is disabled in manual mode.

The rotation direction detection gets activated by pressing the „SET“ switch (at least 1s.) and applying voltage at the same time. The status LED (BLUE) flashes and the actuator gets driven for 2-3 seconds in the desired direction via the swiches ML and MR: The change of the position is determined by the potentiometer and the turning direction of the potentiometer is calculated to "right" or "left"

After releasing the ML or MR-button, the status LED (blue) lights permanently.

If the detection has not been successful, e.g. by faulty potentiometer or drive position on the right limit switch, the status LED (blue) flashes permanently.

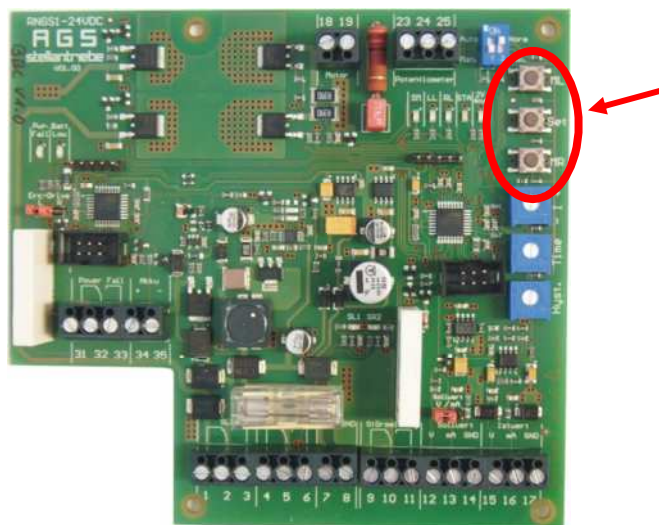
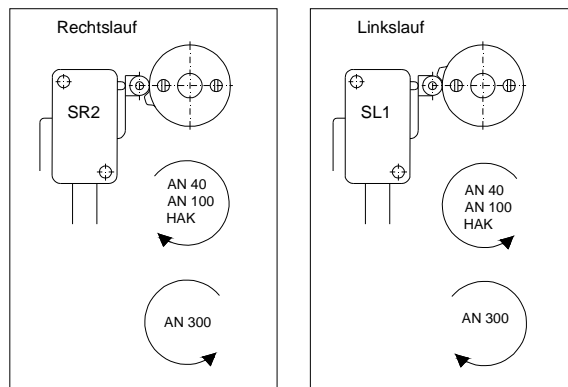

Programming of both End Positions

In manual mode, end positions can be programmed at any time using the SET, MR and ML keys.

Prior to the end position programming, the end-switches and the actual value potentiometer must be set. Manually move the left end position and set the adjusting cam to the SL1 end-switch. Then, manually move the right end position and set the adjusting cam to the SR2 end-switch. The potentiometer will automatically make a rough setting via its slip clutch.

If the potentiometer is standing at its mechanical end stop upon arrival of the end-switch (outside of the coil), it must be re-adjusted using the slip clutch. The voltage at terminals 23 & 24 should be approx. 0.2V (SR2) or 4.8V (SL1).

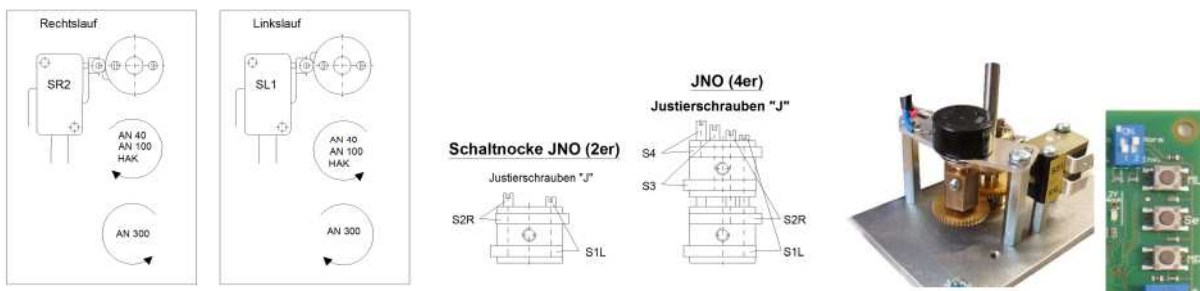

Programming of the right End Position

With the MR key, the drive is moved into the right end position and then the SET key is pressed. Then, the Status LED (BLUE) will flash to indicate that the end position can now be programmed. By pressing the MR key within approx. 3s, the current drive position will be saved as right end position. The Status LED (BLUE) goes back to flashing permanently.

Programming of the left End Position

With the ML key, the drive is moved into the left end position and then the SET key is pressed. Then, the Status LED (BLUE) will flash to indicate that the end position can now be programmed. By pressing the ML key within approx. 3s, the current drive position will be saved as left end position. The Status LED (BLUE) goes back to flashing permanently.

If the SET key has been accidentally pressed, you can wait until the flashing of the Status LED (BLUE) becomes permanent again. The permanent flashing indicates that the started end position programming has been completed or cancelled due to timeout.

Manual Movement in both Directions

With the MR key, the drive is manually driven to the right side until the mechanical end-switch has been activated. During operation, the SR2-LED (GREEN) is on. A programmed end position switch-off is ineffective. The activation of the end-switch is signalled by the SR2 LED (GREEN).

With the ML key, the drive is manually driven to the left side until the latest mechanical end-switch has been activated. During operation, the SL1-LED (YELLOW) is on. A programmed end position switch-off is ineffective. The activation of the end-switch is signalled by the SL2 LED (YELLOW).

Automatic Mode (Auto)

The automatic mode is used for standard operation of the position controller by means of a setpoint control signal and an actual value feedback. It must be ensured that an inspection of the drive regarding the end-switches and the rotation direction as well as regarding the correct programming of the end positions has been performed successfully in advance.

The SET, MR and ML keys are completely locked in the automatic mode. Within the programmable end positions, the drive moves angle-proportionally according to the pre-set target size.

Normal Operation - "Inv / Norm" switch on Norm

Minimum setpoint means right end position.

Maximum setpoint means left end position.

Invers Operation - "Inv / Norm" switch on Inv

Minimum setpoint means left end position.

Maximum setpoint means right end position.

The LED (BLUE) status flashes permanently.

Die RL-LED (GREEN) only flashes during movements of the drive to the right.

Die LL-LED (GREEN) only flashes during movements of the drive to the left.

Lower Deviation / Discontinuation Setpoint

During selection of the setpoint / actual value range 2 ... 10V and 4 ... 20mA, the clear lower deviation of the minimum setpoint is detected as a discontinuation and is therefore signalled as an error.

Error condition: Setpoint 0 ... 1.6V or 0 ... 3.2mA at range selection 2 ... 10V and 4 ... 20mA

The fault signal relay reports faults with a delay of approx. 1s, the corresponding SM-LED (RED) flashes continuously. The Status LED (BLUE) flashes continuously in a 0.25s change.

The actuator turns to the position of the right end position (rating as the minimum setpoint).

Having removed the failure the actuator immediately goes back to the regular operating condition and proceeds in accordance with the setpoint input.

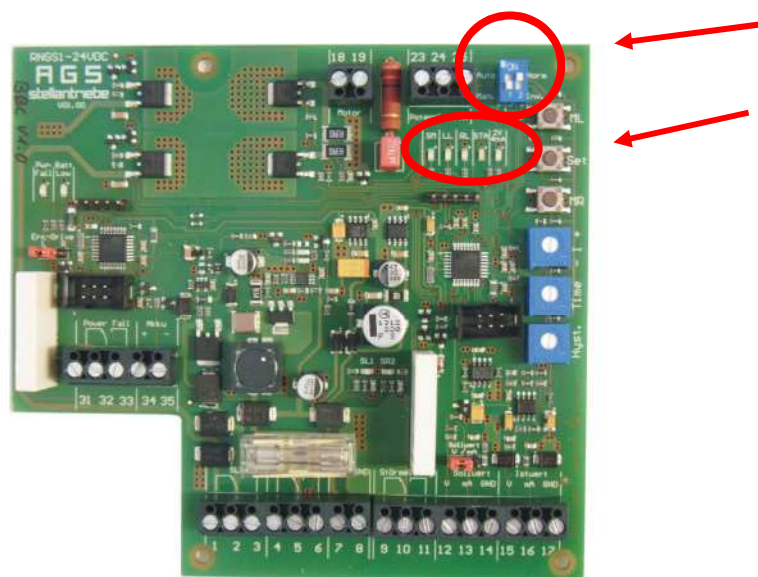

Blocking of the Drive, Overload Detection

A blocking of the drive is only detected in the automatic mode. With the "Power" potentiometer, the power limit for the motor and, along with it, the maximum speed for the drive can be adjusted. If this set power limit is exceeded, the motor is switched off and the fault signal relay is activated. The Status LED (BLUE) is switched off, all keys besides SET are blocked.

After remedying the fault, the drive can be restarted by pressing the SET key and switching off and on of the 24VAC operating voltage.

In automatic mode, the drive reacts immediately after the restart to the defined setpoints.

In manual mode, the drive can be moved manually after the restart.

Hysteresis / Control accuracy

ca. 1 - 6 % of the max. displacement, depending on the regulating time, adjustable via Poti „Hyst%“

Only when reversing the potentiometer "Hyst%" adjustable hysteresis is effective for the assessment of the control signal.

Exception: After switching on the operating voltage, once no hysteresis is effective, the actuator will respond with minimum threshold.

Speed Control

With the "speed" potentiometer, the speed of the motor or of the drive can be changed. When reducing the speed, the torque of the drive will be reduced.

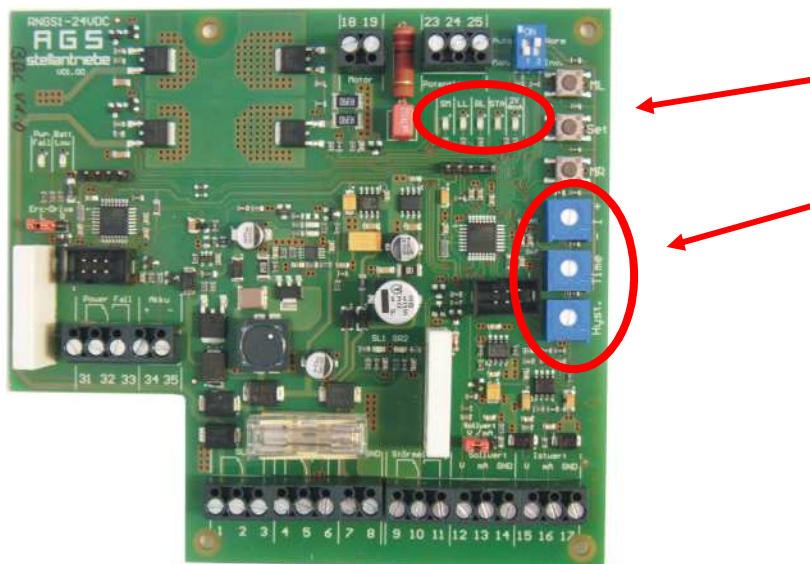

Overview LED Functions

Manual Mode

RED always on in manual mode

Set setpoint / actual value range:

BLUE 3x FLASHING, then OFF until none of the SET or MR and ML keys are pressed.

Rotation direction detection started:

RED, GREEN and BLUE

Rotation direction detection implemented and detected:

RED and BLUE 3x FLASHES then OFF until SET key is released

Rotation direction detection implemented and NOT detected:

RED and BLUE FLASHES permanently

Manual motor operation:

RED, BLUE and GREEN for right turn or YELLOW for left turn

End position programming initiated:

RED and BLUE FLASHES until timeout or execution of the setting

End position programming executed: Immediate change after normal operation

Normal operation standstill:

RED and BLUE

Normal operation with motor movement:

RED, BLUE and GREEN for right turn or YELLOW for left turn

additionally: ESR GREEN for activation of right end-switch

ESL YELLOW for activation of left end-switch

Automatic Mode

Clear lower deviation of the minimum control setpoint in the configuration 4...20mA and 2...10V

(from approx. 3.2mA or 1.6V) as discontinuation detection:

YELLOW FLASHING (as indication for the discontinuation)

Clear lower deviation of the minimum control setpoint in the configuration 4...20mA and 2...10V

(from approx. 3.2mA or 1.6V) as discontinuation detection:

RED and BLUE FLASHING (as indication for the discontinuation)

Normal operation standstill:

BLUE

Normal operation with motor movement:

BLUE and GREEN for right turn or YELLOW for left turn

No power supply:

RED (Failure notice Pwr.-Fail)

Low or no capacitor memory:

RED (Failure notice Con-Low)