

Part-turn / Rotary Actuator AN300-A

Technical Data

Torque	max. 300Nm
Actuating time	17s - 260s/90°, 100% synchronism
Swivelling / rotary range	10° - 90°, fine adjustable optional up to 72 rotations
Voltage	230V AC, 50 / 60 Hz Options 24/115VAC, 400VAC, 12/24VDC
Amb.-Temp.	-15°C to +60°C Optional -40 / +80°C
Protection class	IP 67 – for outdoor installation

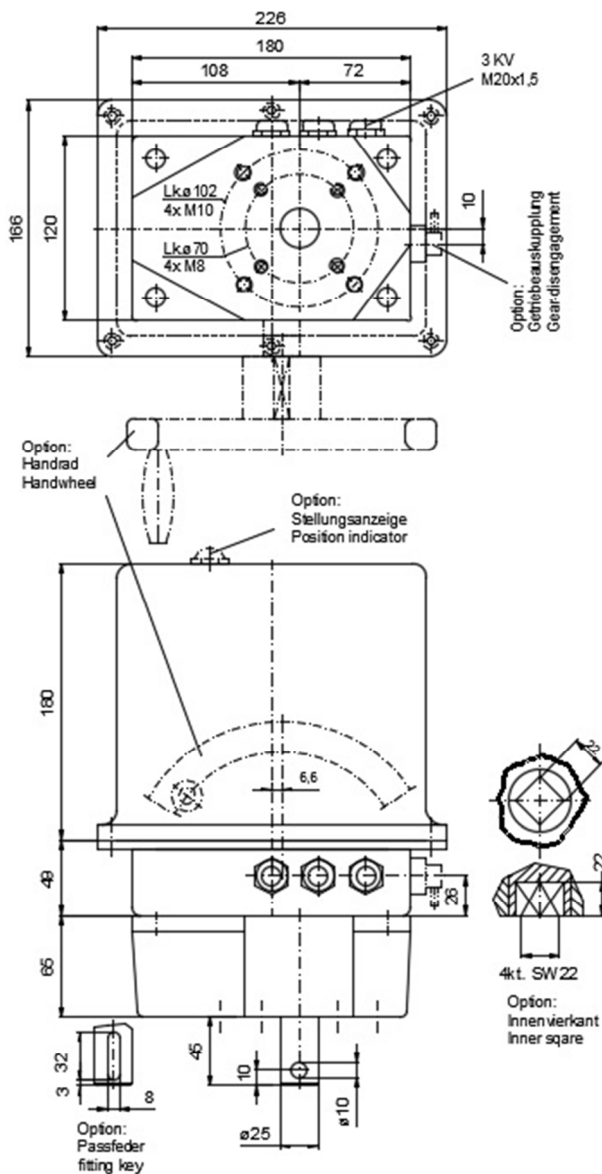
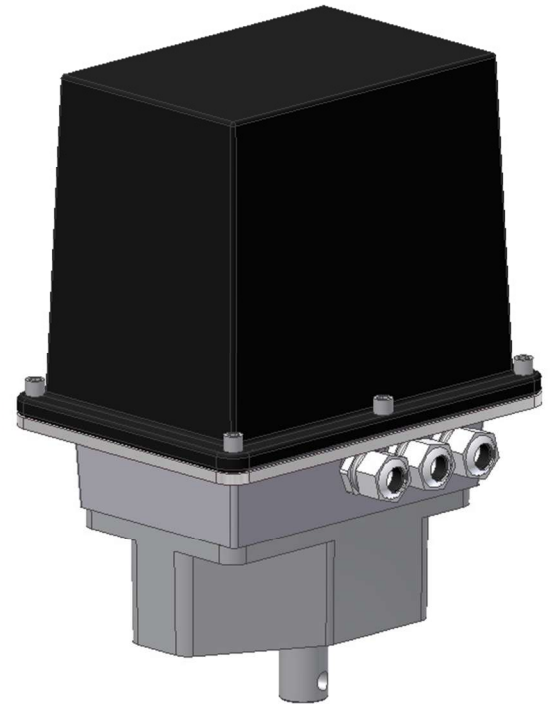

General data

Robust, weatherproof design built to industrial standards

Maintenance-free

To fit any fitting position

Short-circuit proof synchronous motor

No mechanical brake required

Control cam fine adjustable

Numerous options:

Additional switches, Potentiometer

Position indicator or positioner,

Power cut-off

Hand wheel, gear disengagement ...

Other shafts or designs possible

Numerous mounting parts and accessories